

Warmup[®]

The world's **best-selling** floor heating brand™

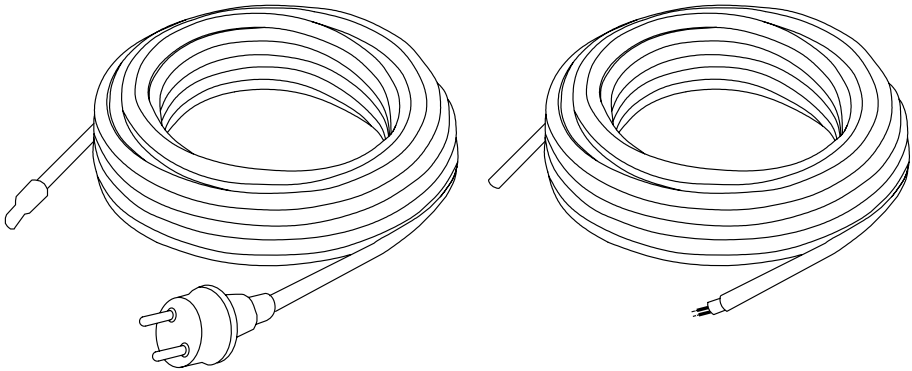

Installation Manual

Self-Regulating Cables

TECHNICAL HELPLINE
0345 345 2288

IMPORTANT

Read this manual before attempting to install your heating system. Incorrect installation could damage the heating system and will invalidate your warranty.



Contents

3	Important Installation Points
4	Introduction
5-6	Product Information
7	Installation Accessories
8-9	Preparation
10-11	Application: In gutter
12-13	Application: Gutter & downspout
14-15	Application: Roof & gutter
16-17	Installations with Roof Features
18-21	Cable Terminations
23	Warranty

If these instructions are followed, you should have no problems during installation. However, if you require assistance at any point, please call our **Technical Helpline**

0345 345 2288

You can also find a copy of this manual, wiring instructions, a list of FAQs and other useful information at our website:

www.warmup.co.uk

Important Installation Points

1. The heating cable may only be connected to a 230VAC supply.
2. Faulty electrical installation can cause a short circuit or an electric shock. To ensure the best possible protection, a 30 mA RCD MUST be fitted. Always Observe the specific electrical and building regulations for your country.
3. The heating cable MUST be installed as per the installation manual.
4. The heating cable must be connected by a qualified electrician in accordance with the current wiring regulations.
5. The heating cable must be installed as per the specified installation plan.
6. The heating cable and connection lead (or plug) must not come into contact with water or other liquids.
7. Ensure that the end cap at the end of the cable does not come under mechanical stress.
8. If you discover that the heating cable is damaged, immediately switch off the 230VAC supply and replace the heating cable.
9. Always protect the heating element against sharp edges, oil or heat.
10. Ensure that the heating cable is positioned at least 30mm from flammable materials.
11. Never place the heating cable in the vicinity of explosive substances, objects or gases.
12. Do not bend the cable below the minimum bending radius of 25mm. The cable may suffer permanent damage in sections where the cable is bent below this radius.
13. The gutter heating cable should be powered-up at the beginning of the winter period.
14. Installation of the cable should only take place when the ambient temperature is between 0°C and 27 °C.
15. Do not energise above 10°C.
16. The self-regulating cable should only be installed on inclined roofs.
17. Do not install the cable to remove ice dams that have already formed or to clear the roof of existing ice or snow.
18. Do not use the self-regulating cable for snow melt on driveways or sidewalks, or as frost protection. Warmup have products designed specifically for these applications.
19. Do not use the self-regulating cable on wooden gutters or downspouts.

Safety Guidelines

Incorrect design, handling, installation, could damage the system and may result in inadequate frost protection or electric shock. To minimize these risks and to ensure that the system performs reliably, read and carefully follow the information, warnings, and instructions in this guide.

Ensure that the heaters are connected by a qualified electrician as per the current wiring regulations and are protected by a 30mA RCD at all times.

Introduction

Self-regulating heating cable

The ability to vary heat output in accordance with ambient temperature and resulting levels of snowfall and ice buildup is what makes the self-regulating cable beneficial when compared to constant wattage cables. The resulting lower energy consumption and costs are major advantages.

When the temperature at the site of installation decreases, the cable will react by increasing its heat output. Contrarily, when the ambient temperature increases the cable will decrease its output. The intention is to maintain a constant temperature above freezing for the protected object, i.e. gutter or pipe, which eliminates damage from cracks, icicles or blockages.

Fig 1: Graph showing the output temperature of the cable at ambient temperature

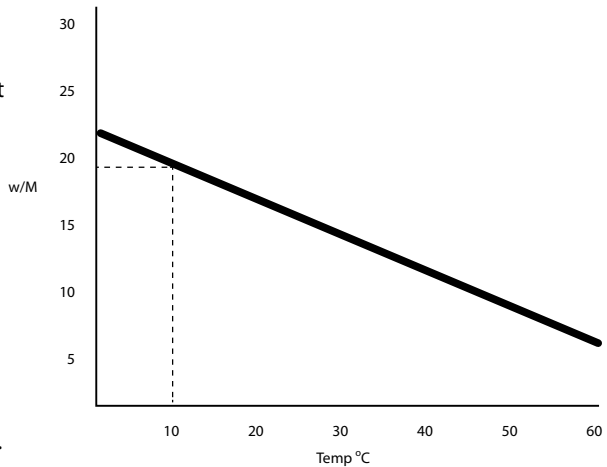

As the cable regulates its wattage, the current will vary with the ambient temperature. When selecting the length of cable to be used, it is necessary to calculate the current that will be loaded onto the 16 A thermostat relay. For this reason, there is a maximum circuit length, which cannot be exceeded. For this cable length calculation, refer to the table below.

When properly installed and operated, this product creates a path for melted snow and ice to drain from the roof to the ground.

Maximum self-regulating cable length at 230 Vac		
Temperature	Cable length (m) with Fuse Amperage of:	
	10A	16A
10 °C	79m	110m
-15 °C	49m	71m
-20 °C	42m	58m

Product Information

Application

The heating cable is self-regulating, which means it will react to the ambient temperature and regulate its heat output based on the heating requirements.

Technical Data

Power Output	20 W/m at 10°C
Voltage Supply	230 V AC, 50 Hz
Bus Bar	Coated Copper
Inner Insulation	Thermoplastic Elastomer
Metal Sheathing	Coated Copper
Outer Sheath	Thermoplastic Elastomer
Outer Diameter	10.6 mm x 5.9 mm
Minimum installation Temperature	-30 deg C
Application Temperature up to	-30 deg C
Operating temperature- Switch on	Max. 65 deg C
Operating temperature- Switch off	Max. 85 deg C
Min. bending Radius	25 mm
Circuit Breaker	Max 16 A
IP Rating	IPX7

Product Information

Model	Form	Length (m)	Wattage @10 °C	Watts/m @10 °C
W20SR500	Terminated with Schuko plug	25	500	20
W20SR600	Terminated with Schuko plug	30	600	20
W20SR1000	Terminated with Schuko plug	50	1000	20
W20SR1600	Terminated with Schuko plug	80	1600	20
W20SR/m*	Unterminated	cut to length	W = 20 x Length	20

*See page 6 for guidance on selecting Warmup non-terminated cables.

Product Information

Due to the parallel power supply to the cable's heating core, it is possible to cut the cable at any point along its length, making project planning and installation easier.

To maximise the benefits of this feature, Warmup offers self-regulating cable in 3 formats:

1. Terminated with the Schuko plug for easy installation
2. 500m on the reel, unterminated (see image to the right)
3. Bespoke cut to length service for unterminated cable:
 - a. Minimum 20m
 - b. Maximum 500m (a full reel)
 - c. Increments in lengths of every metre

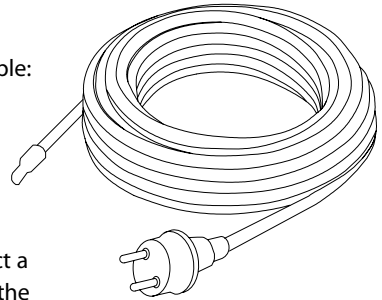
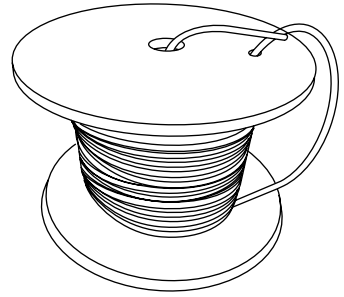

Power and end termination kits are available to connect a cold lead for supply connection and to seal the end of the circuit respectively. For details on cable termination see pages 18-21.

Cable Construction

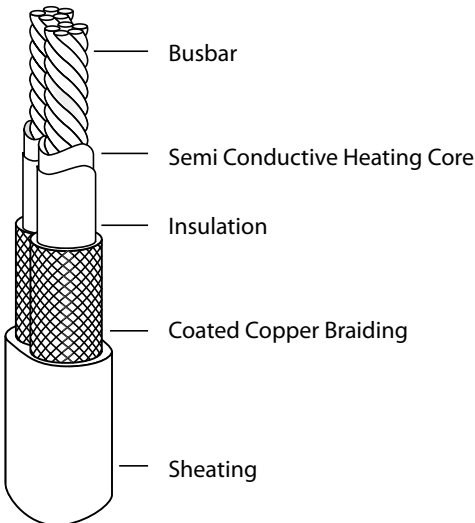

Installation Accessories

1. Items for installation (dependent on installation type)

1. Downspout hanger reel

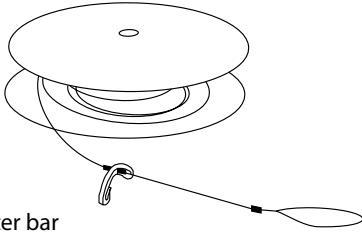

5. End termination kit

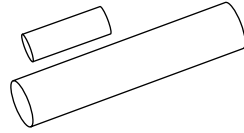

2. Gutter bar



6. Silicon sealant

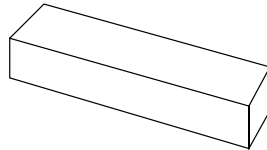

3. Roof fixing clips

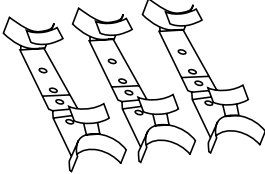

7. T-junction box

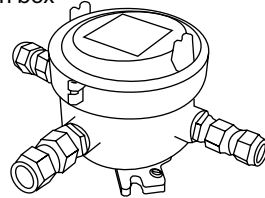

4. Power termination kit

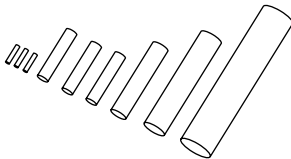

8. Aluminium adhesive tape

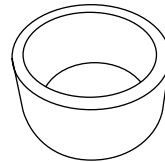

2. Important Installation and Safety Tips

The installation must be carried out by a qualified electrician.

The self-regulating cable must be connected to a suitable socket or junction box and must always be protected by a 30mA RCD per the current wiring regulations.

If the RCD trips during normal operation, and cannot be reset, there is likely a fault in the circuit. No attempt should be made to re-energise the cable, and the RCD must not be bypassed in any circumstances. Consult a qualified electrician.

Preparation

Before fitting the heating cable make sure that the area around the cable is freely accessible and that there are no sharp edges. Inspect the heating cable before using it for any sign of damage.

Allow the cable to warm up to room temperature before installing.

Ensure gutter is clear removing any leaves or debris from the gutters and downspouts.

For a shingled roof installation of the self-regulating cable should only be done between 0 and 27°C. Below 0 °C shingles are brittle and may break off when lifted to install roof clips. Above 27°C shingles may be warm and may tear when lofted to install roof clips.

For each roof area that has cable, the corresponding gutter must also have cable.

Where using a junction box, it should be mounted in a sheltered area.

Start the installation at the junction box, leaving a drip loop where the cable exits the junction box.

If working directly on the roof during installation, it is advised to mark the cable with chalk beforehand. A project drawing will help with planning the length of cable per roof feature.

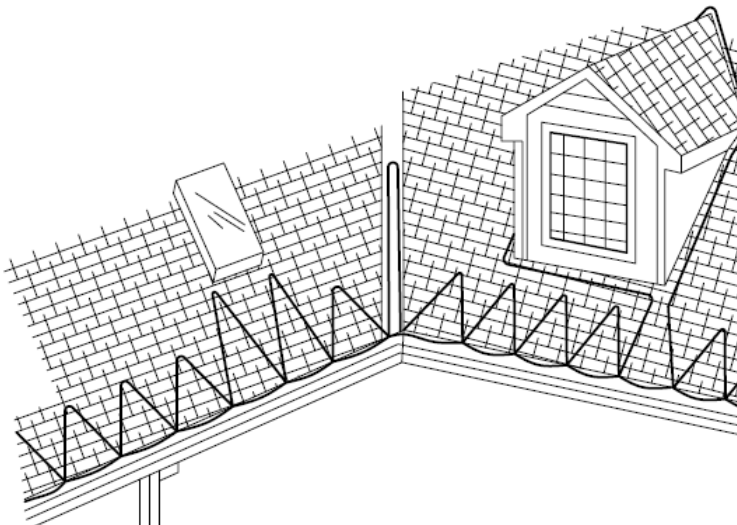

Preparation

The length of cable required will obviously depend on the project requirements and the location on the building to be heated.

The most typical installations are covered in this manual, please refer to page 6 onwards for details.

The table below outlines the cable length requirements for installations in different projects:

Eave overhang (mm)	Multiplier for roof without gutter
305	3.0
610	4.3
915	5.8
1220	7.1

Installation area	Length requirements
Roof edge	Length of roof x overhang multiplier
Gutter	1m of cable per metre of gutter, if wider than 15cm use double run of cable
Downspout	2m of cable per metre of downspout
Roof valley	1.8m of cable per valley
Dormer perimeter	1m of cable per metre of dormer perimeter

Eave overhang (mm)	Triangle Height (mm)
305	458
610	762
915	1066
1220	1372

When heating a roof the cable is laid along the roof line arranged in a triangular pattern. The triangles must extend above the overhang into the warm section of the roof. To determine height of the triangles, please see the table to the right. The distance between the peaks of each triangle is always 610mm or 24" wide.

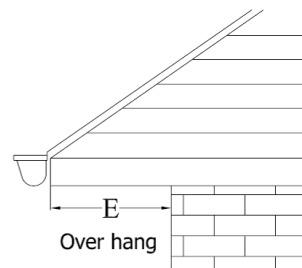
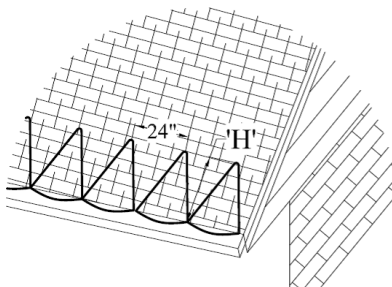

Application: In gutter

The simplest installation occurs when the project requires only de-icing of a gutter.

1. To attach the cable properly it must lie flat in the gutter. The cable should be uncoiled ensuring it is not twisted or tangled.
2. The cable should be held tightly, whilst not touching the gutter itself to prevent heat loss.
3. If treating gutters for ice build up, use a double run of cable.
4. Once the length of cable required is determined, the terminated cable end should be attached to the gutter using an appropriate method, ie aluminium adhesive tape. Permanent methods such as glue or adhesive should not be used.
5. For this installation the gutter bars are used. UV resistant cable ties are pushed through the holes on the bar and fasten loosely so that the cable is held, but not secured.
6. Repeat step 5 with as many bars as required for the gutter length, using 1 clip every 20cm of gutter.
7. For round gutters the bar will need to be bent around the edge of the gutter, and the inside profile. Pliers can be used for this (see Figure 3).
8. Once all bars are attached along the cable, begin adhering them to the inside surface of the gutter. Check the spacing and use the aluminium adhesive tape to hold the bars down.
9. All cable ties should be tightened and trimmed as in Figure 3.

NOTE: The parallel runs of cable should be kept separate, and evenly spaced throughout.



Figure 1. Gutter bar & cable ties

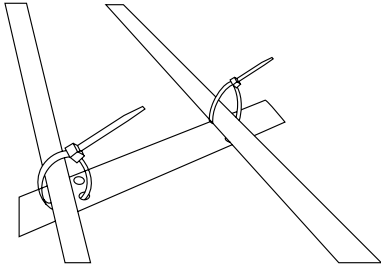

Figure 2. Cable tied to bar

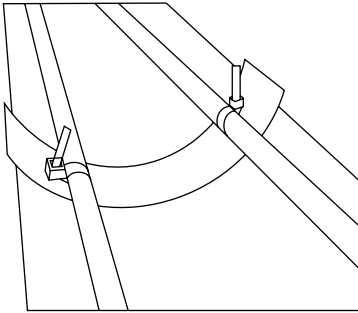

Figure 3. Bar attached to gutter

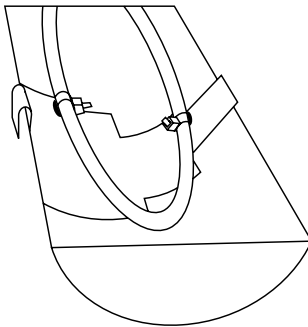

Figure 4. Bar adhered to gutter with aluminium tape

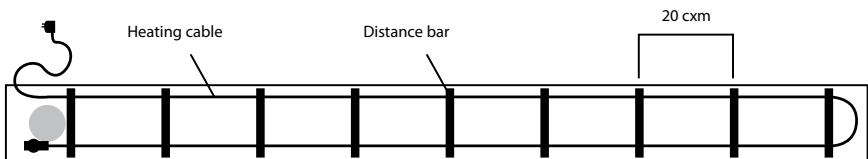

Figure 5. Final installation in a gutter

Application: Gutter & downspout

There are 2 types of downspout installations:

- those where the downspout is in the middle of a gutter length and
- those where the downspout is at the end of the gutter run

Where the downspout is in the middle of a gutter run, the cable will need to route down and back up, to continue along the gutter. The cable should not extend beyond the end of the downspout. Take this into account when calculating cable length for the project.

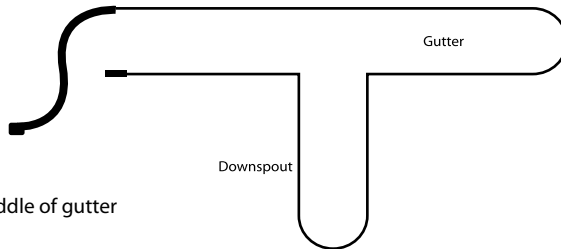

Type 1: Downspout in middle of gutter

Remember to avoid overheating the cable, as this increases the risk of fire or electric shock. No part of the downspout should be inside a building.

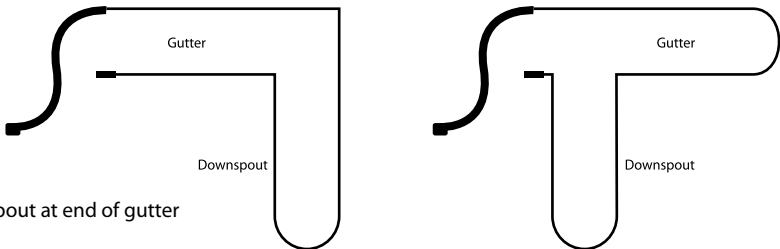

Type 2: Downspout at end of gutter

1. For downspout installations running along the gutter, the cable should be routed down the pipe and back up.
2. Once the length of cable required is determined, the terminated cable end should be attached to the gutter before the downspout using an appropriate method, ie aluminium adhesive tape. Permanent methods such as glue or adhesive should not be used.
3. The length of steel wire needed should be measured from the looped end of the downspout hanger reel. This includes the length of gutter leading to the downspout, and for the downspout itself. The cable should be flush with the end of the spout.

4. The cable is then attached to the downspout hanger using the clips (see Figure 3). The clips are spaced at 40mm intervals.

5. On the end of the hanger reel is a looped end for holding the run in place and keeping the steel wire tensed. Attach this loop to a secure object which will not break or fall off with the weight of the cable being supported in the downspout.

6. Where the downspout is at the end of the gutter to be heated, parallel runs of the cable will be supported via the steel wire, and return via the same gutter. Where the gutter continues after the downspout, the cable will only have parallel double runs in the downspout itself, and will continue along the gutter as required.

7. Once all parts of the cable are clipped in, the cable with the steel wire can be dropped into the downspout, ensuring the steel wire is in tension to keep the cable in paralleled equal spacing.

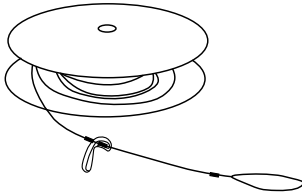

Figure 1. Downspout hanger

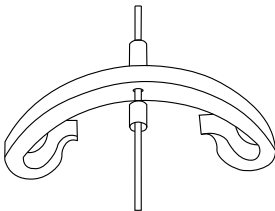

Figure 2. Downspout hanger clip

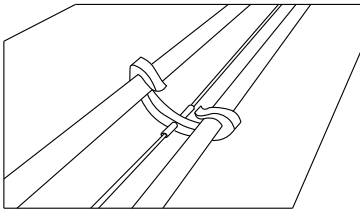

Figure 3. Downspout hanger clip holding cable

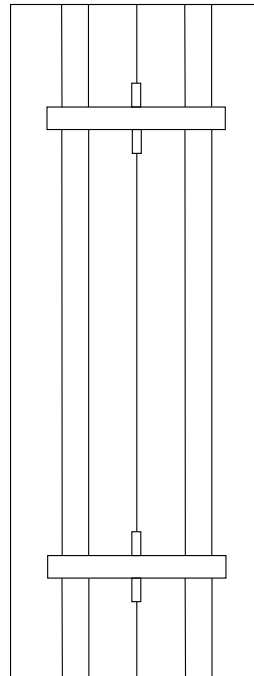

Figure 4. Cable held in parallel in the downspout

Application: Roof & Gutter

For effective heating along the roof line, the cable is arranged in a triangular pattern (Figure 1). The triangles must extend above the overhang into the warm section of the roof (Figure 2). To determine height of the triangles, please refer to the table below.

1. For installations on the roof and gutter, the roof clips are used. Using the information on this page and page 9, calculate the height of the triangle formation for the roof heating. The triangle width is fixed at 60cm / 24" from peak to peak. The amount of overhang the roof has from the building will affect the height of the triangles.

2. Determine the total length of cable required for the project.

3. Draw out a plan for the project and mark the positions of triangle peaks on the roof using chalk. This will make installation easier.

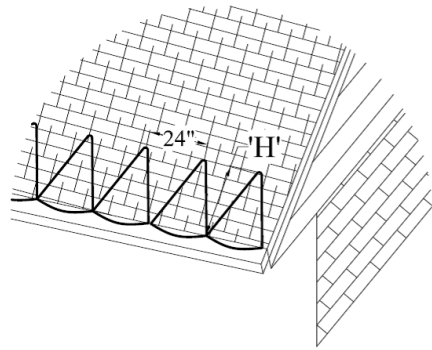

Figure 1. Triangle formation for roof heating

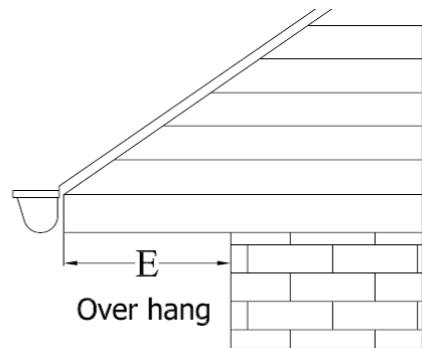
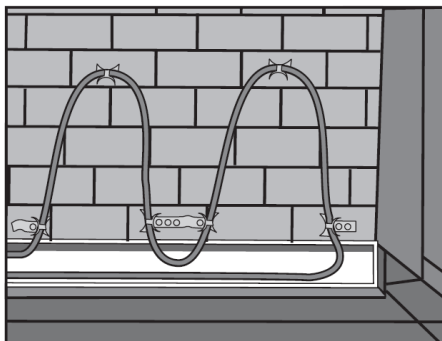

Figure 2. Overhang distance

"E" Eave overhang (mm)	"H" Loop Height (mm)
305	458
610	762
915	1066
1220	1372

"E" Eave overhang (mm)	Multiplier for roof without gutter
305	3.0
610	4.3
915	5.8
1220	7.1



4. Also mark the cable with any points where the peak of a triangle is or wherever the cable is to be fixed to the roof.

5. A double clip is used to secure the heating cable looped at the roof edge, ensuring a drainage channel to the gutter.

6. A single clip is used to fasten the cable at the stop of the saw tooth arrangement.

7. Fasten the clips to the roof with roofing nails or screws, applying silicon sealant under the clip to provide a water proof sealant.

8. After installing the clips on the roof, thread the heating cable around the clips. Use extra clips in any location where the cable is subject to excess stress or movement.

9. Use pliers to close the clips firmly around the cable, taking care not to crush or damage the cable.

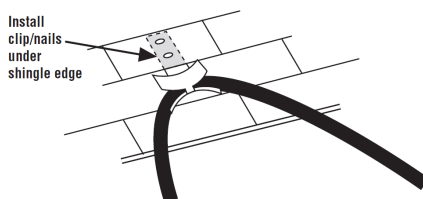
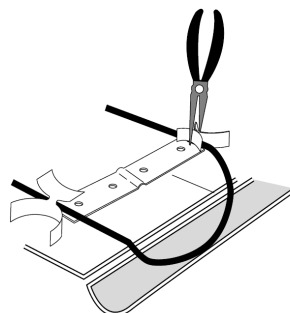
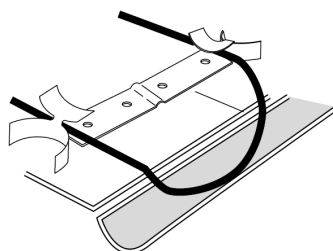
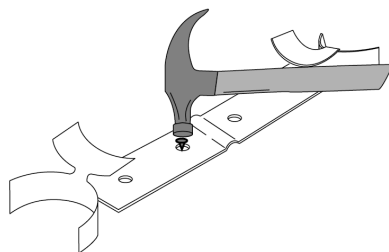
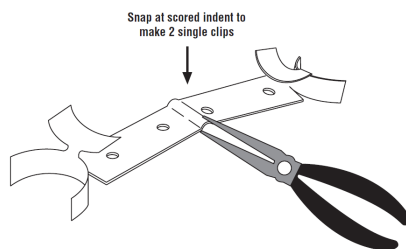

Installations Including Roof Features

Installation area	Length requirements
Roof edge	Length of roof x overhang multiplier
Gutter	1 m of cable per metre of gutter, if wider than 15cm use double run of cable
Downspout	2m of cable per metre of downspout
Roof valley	1.8m of cable per valley
Dormer perimeter	1 m of cable per metre of dormer perimeter

For window features where water may build up and form ice, it is also possible to customise the installation. This will increase the length of cable required. Below is an outline as to the recommended installation for such roof features.

TIP: If you will be working directly on the roof during the installation, you may want to mark the cable pattern with chalk before attaching the cable. If working from a ladder, you will probably want to lay out the pattern as you attach the cable with the clips. Making a drawing of your roof and your planned pattern on paper is recommended.

Installation for skylights

Skylight areas are also treated with the “triangle pattern approach”. However, the height of the triangles is increased so that it extends to 15cm / 6” below the skylight.

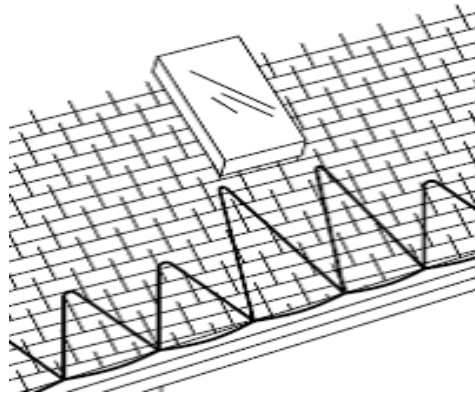

Installation for dormers

The cable should be arranged up and down around the dormer.

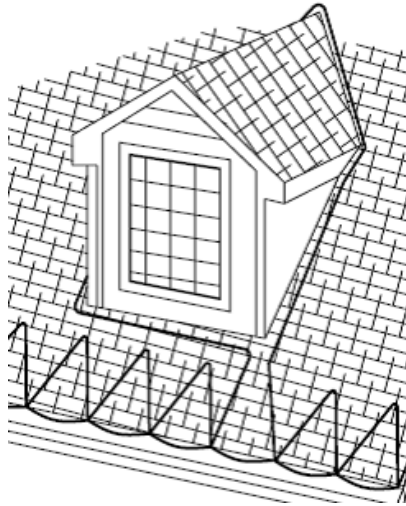

Installation for valleys

If there is a valley in your roof, you must route cable up and back down the valley a minimum of 1 metre. Extend the cable higher if the warm area of your roof is higher.

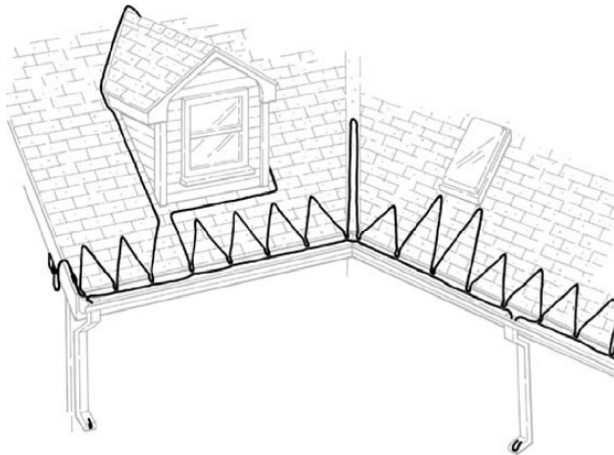

Cable Termination - End Termination

The Warmup termination kit contains 2 sets of sleeves and crimps, one for terminating the end of the cable, and one for terminating the power connection.

End Termination

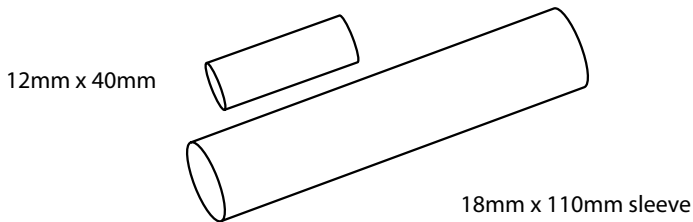

The termination kit

1. Remove 40 mm length of outer sheath of heating cable.
2. Unravel the exposed metal braid.
3. Cut extra metal braid up to outer sheath of heating cable.
4. Slide 12 mm x 40 mm sleeve over end of the cable to cover about 10 mm of cable outer sheath and shrink by hot air gun.
5. Slide 18 mm x 110 mm sleeve over preshrink inner sleeve and also shrink outer sleeve by hot air gun.

End Termination

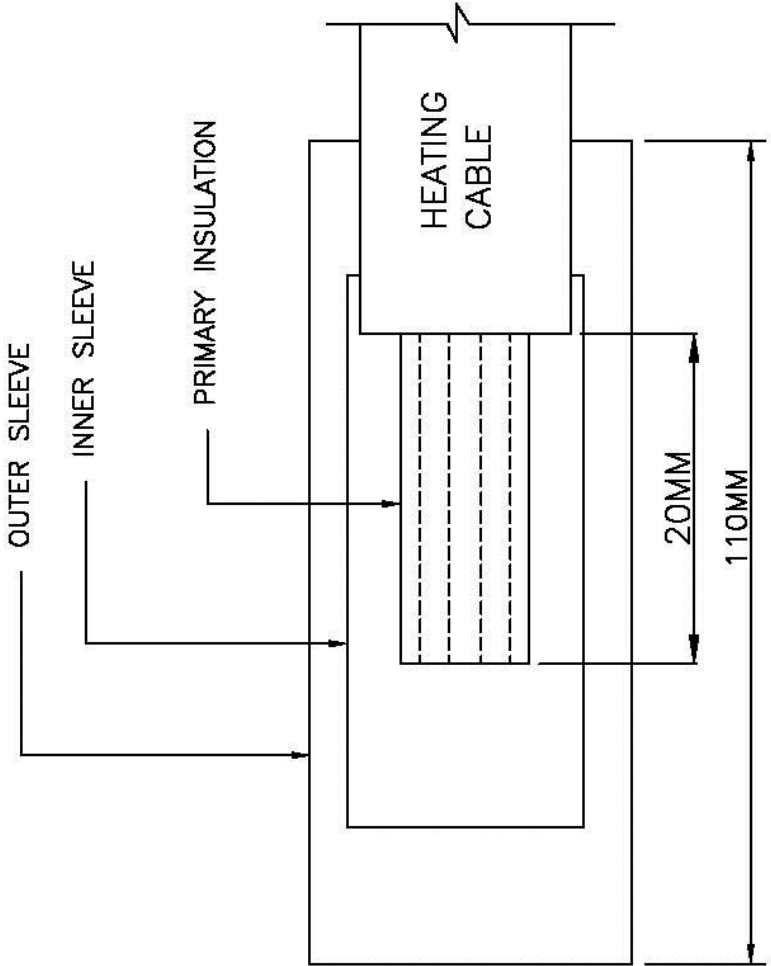

Cable Termination - Power Termination

Power Termination

(Refer to diagram opposite)

1. Cut heater tracer cut off at a required length.
2. Remove tracer outer sheath approximately 50 mm from the end.
3. Unravel metal braid up to outer sheath.
4. Twist and cut the braid leaving approximately 10 – 15 mm near outer sheath.
5. Strip about 20 mm insulation and semi conductive material over both the bus bars
6. Remove about 90 mm outer sheath over cold lead.
7. Cut approximately 60 mm insulated Neutral and live cold cores (brown and blue).
8. Strip all the three cores for approximately 10 mm.
9. Slide 18 mm x 160 mm sleeve over cold lead and then slide 12 mm x 110 mm sleeve over cold lead. Don't shrink the sleeves.
10. Slide 4 mm x 30 mm sleeve over earth core.
11. Slide lug over twisted metal braid and slide stripped earth core in to lug. Crimp lug by using crimping tool.
12. Slide 4 mm x 30 mm sleeve over lug to keep lug in mid of sleeve and shrink the sleeve by hot air gun.
13. Slide one 6 mm x 30 mm over neutral core of cold lead and one 6 mm x 30 mm sleeve over live core of cold lead.
14. Slide one lug on one bus bar and slide another lug on other bus bars.
15. Slide Neutral core in to lug of one bus bar and live core in to lug of another bus bar and crimp both lugs by using crimping tools.
16. Slide both 6 mm x 30 mm sleeves over the crimped lugs to keep lugs in mid of the sleeves and shrink the sleeves by hot air gun.
17. Slide 12 mm x 110 mm sleeve over the terminations and shrink by hot air gun.
18. Slide 18 mm x 160 mm sleeve over preshrink sleeve and shrink.

Power Termination

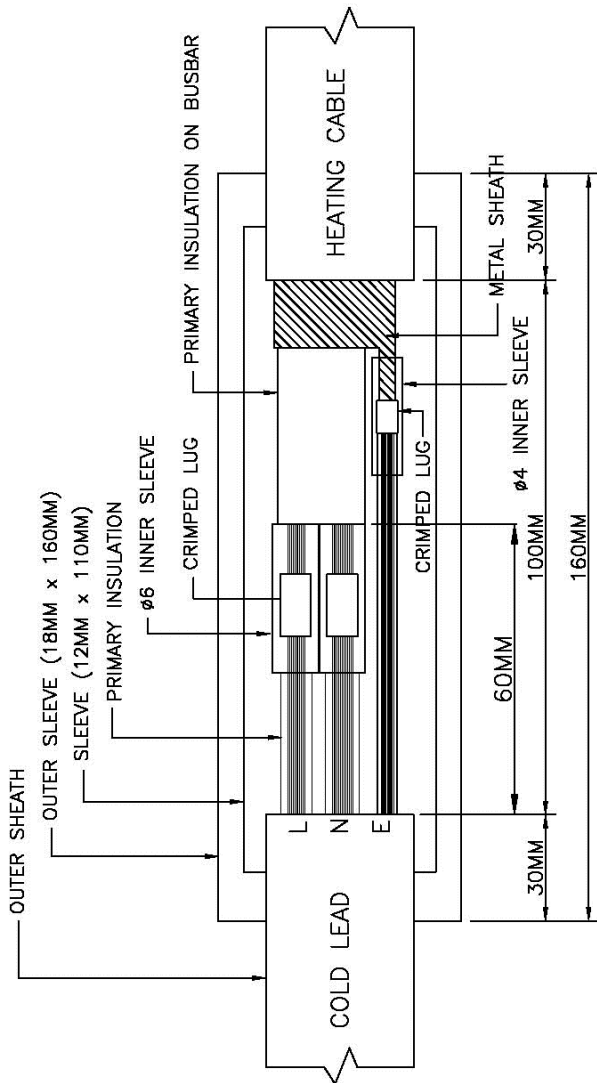

Warranty



Warmup® Frost Protection Cable is guaranteed for a period of 5 years by WARMUP PLC (“Warmup”) to be free from defects in materials and workmanship under normal use and maintenance, and is guaranteed to remain so subject to the limitations and conditions described below:

The 5 year Guarantee applies:

1. Only if the unit is registered with Warmup® within 30 days after purchase. Registration can be completed online at www.warmup.co.uk. In the event of a claim, proof of purchase is required, so keep your invoice or receipt – such invoice should state the exact model that has been purchased.
2. Only if the heater has been earthed and protected by a 30mA Residual Current Device (RCD) at all times.
3. Only if the heaters have been tested and electrical work and connections have been undertaken by a qualified electrician in accordance with IEE regulations and in accordance with these installation instructions.

During the period of guarantee, the manufacturer will arrange for the heater to be repaired or (at its discretion) have parts replaced.

If the heater fails due to damage caused during installation, this guarantee does not apply.

THE MANUFACTURER SHALL IN NO EVENT BE LIABLE FOR INCIDENTAL OR CONSEQUENTIAL DAMAGES, INCLUDING BUT NOT LIMITED TO EXTRA UTILITY EXPENSES OR DAMAGES TO PROPERTY.

WARMUP® PLC is not responsible for:

1. Damage or repairs required as a consequence of faulty installation or application.
2. Damage as a result of floods, fires, winds, lightning, accidents, corrosive atmosphere or other conditions beyond the control of the manufacturer.
3. Use of components or accessories not compatible with the units.
4. Normal maintenance as described in the installation and operating manual.
5. Parts not supplied or designed by the manufacturer.
6. Damage or repairs required as a result of any improper use, maintenance, operation or servicing.
7. Failure to start due to interruption and/or inadequate electrical service.
8. Any damage caused by frozen or broken water pipes in the event of equipment failure.
9. Changes in the appearance of the product that does not affect its performance.

Warmup®

The world's **best-selling** floor heating brand™

Warmup plc

W: www.warmup.co.uk

E: uk@warmup.com

T: 0345 345 2288

F: 0345 345 2299

The WARMUP word and associated logos are trade marks. © Warmup Plc. 2021 – Regd. TM Nos. 1257724, 4409934, 4409926, 5265707. E & OE.

Warmup plc ■ 704 Tudor Estate ■ Abbey Road ■ London ■ NW10 7UW ■ UK

Warmup GmbH ■ Ottostraße 3 ■ 27793 Wildeshausen ■ DE

Warmup- IM- WSR_Self Regulating - V2.1 2021-06-22_EN